

# PJS – Přednáška číslo 5 - Dodatek

Jednofázový zkrat:

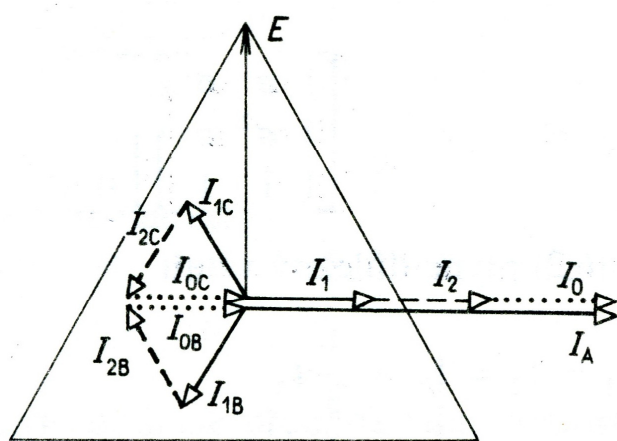

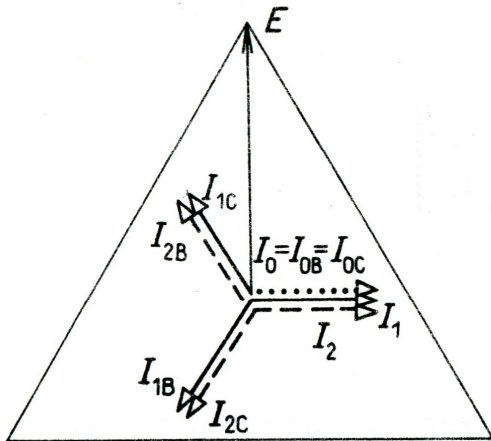
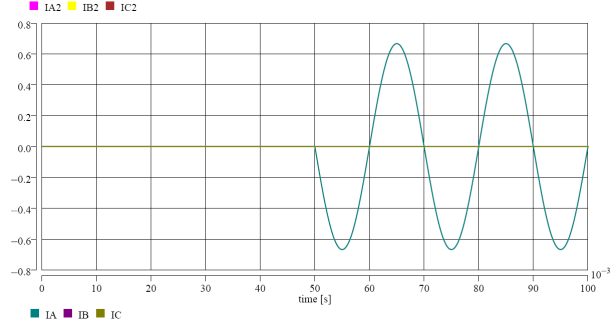
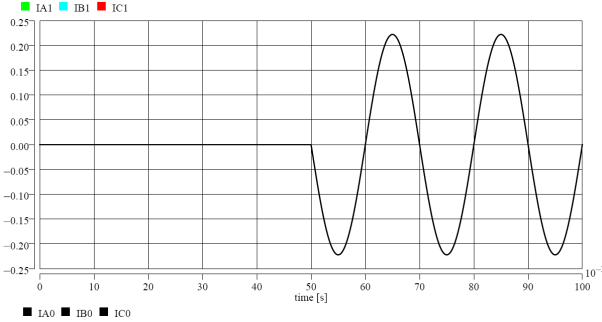
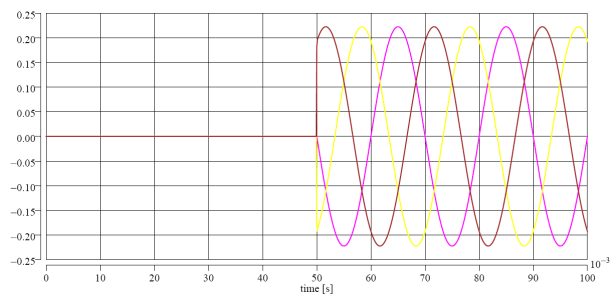
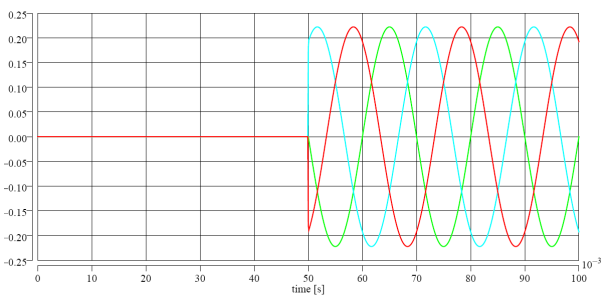
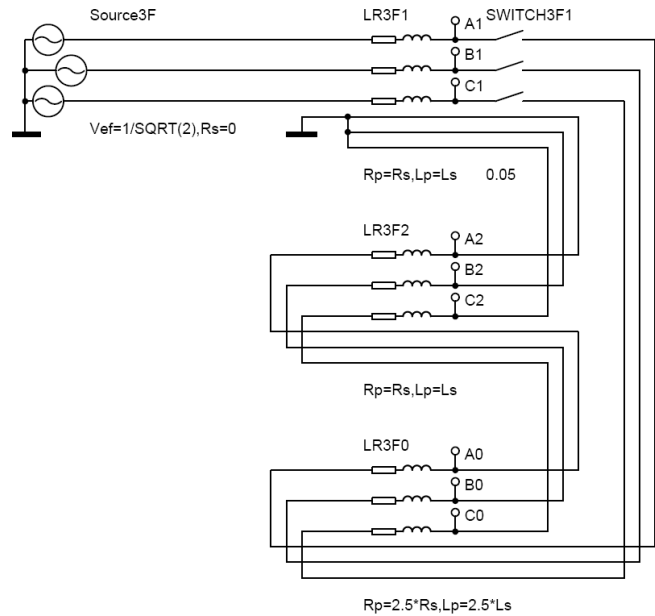
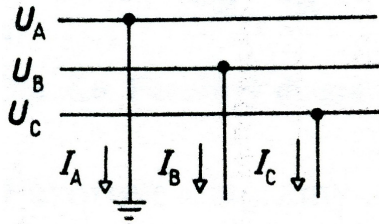
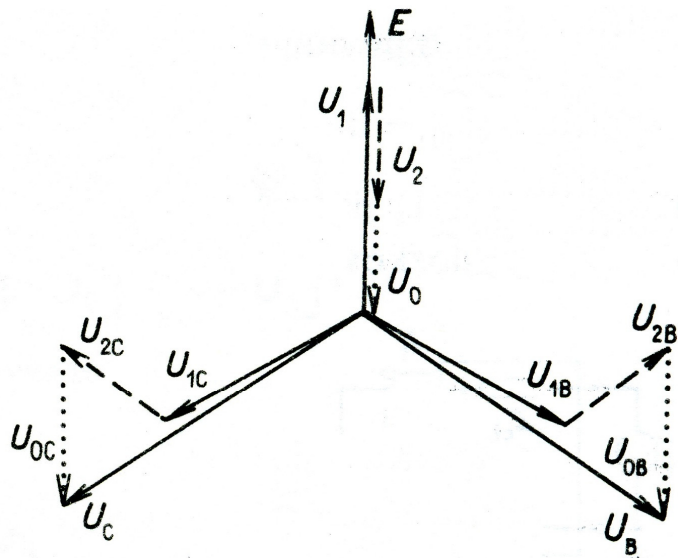
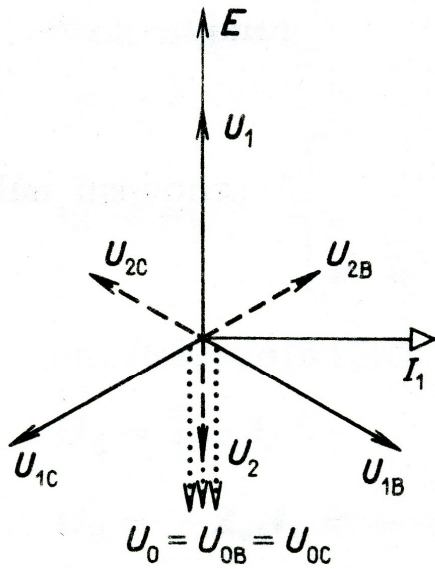
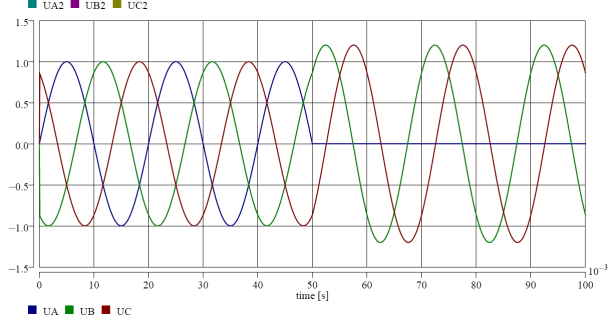
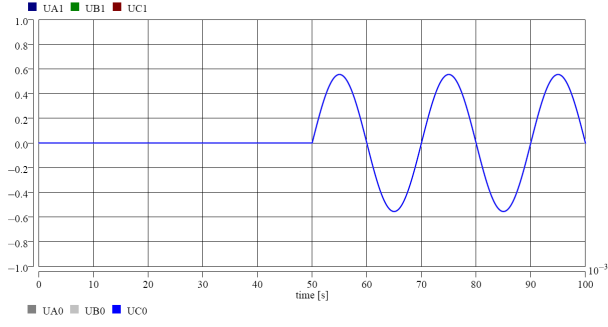
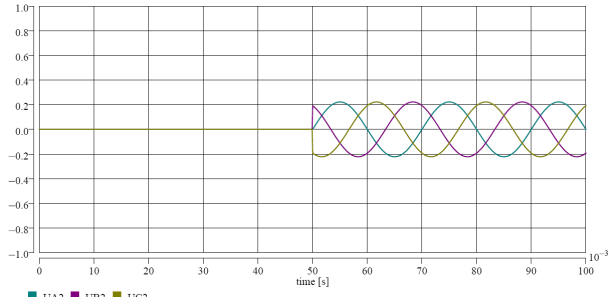
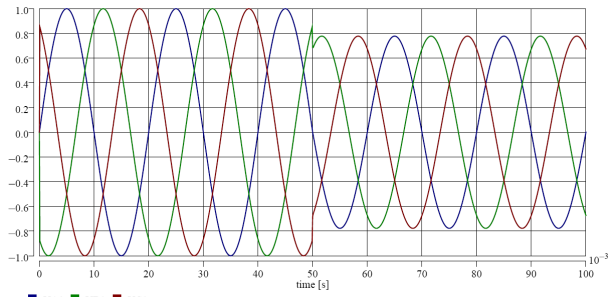

Dvoufázový zkrat:

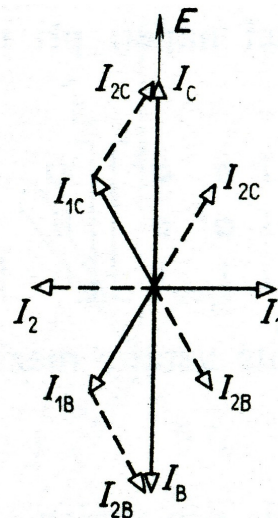
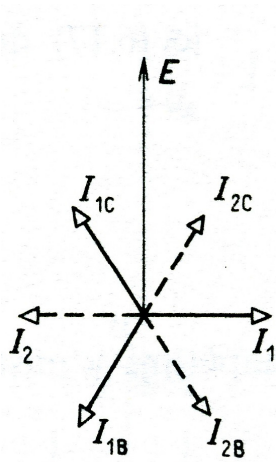
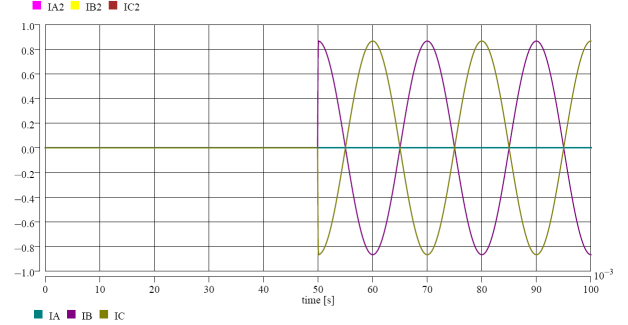
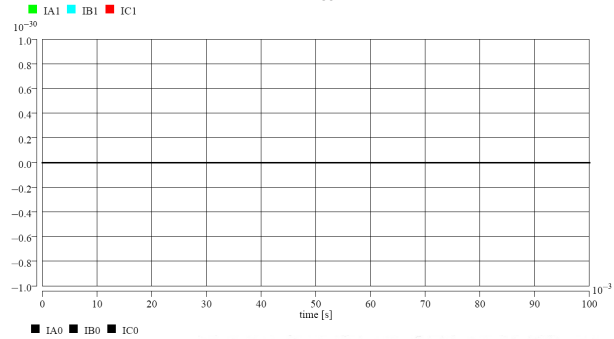
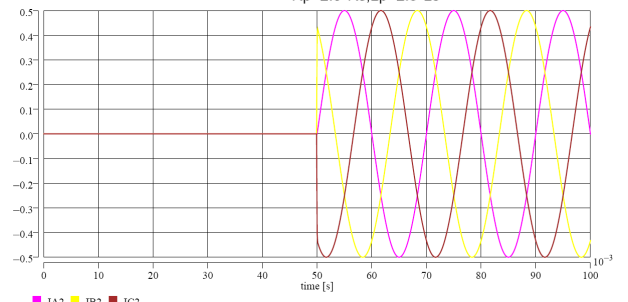
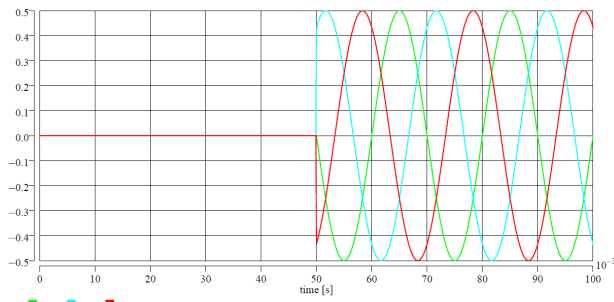
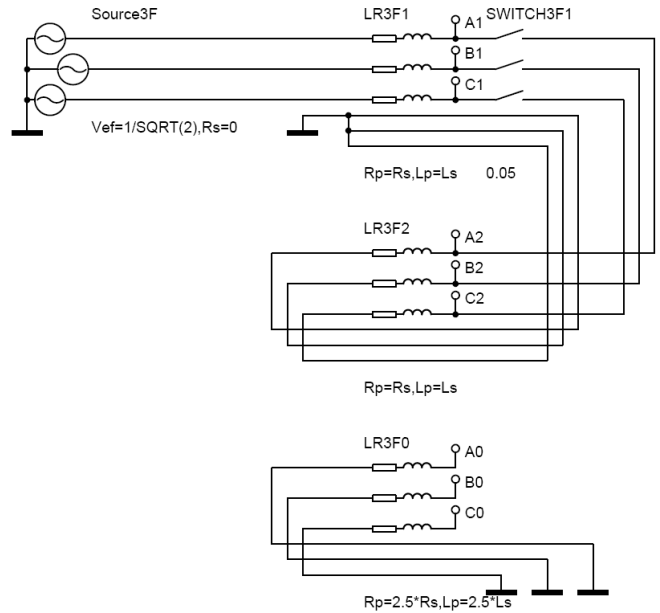
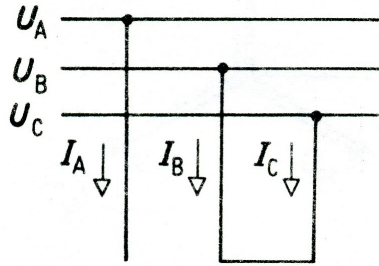

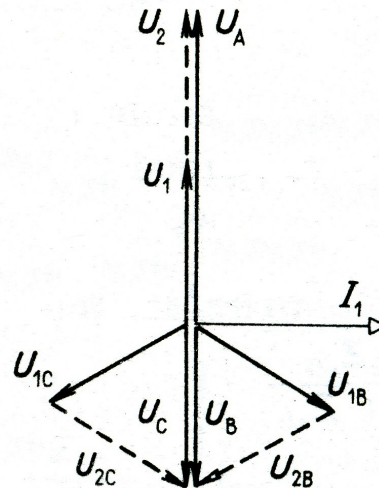
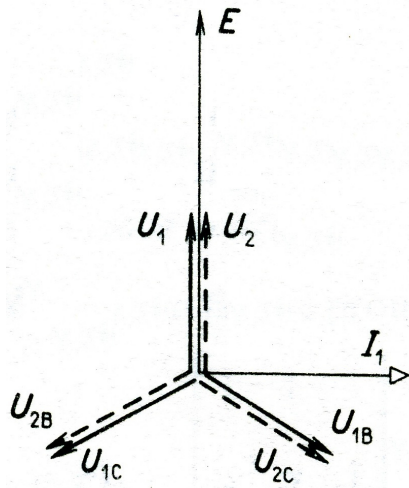
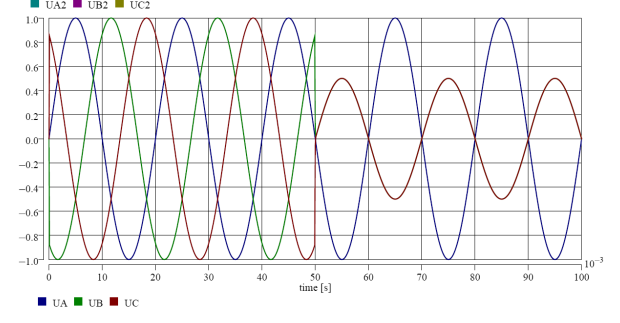
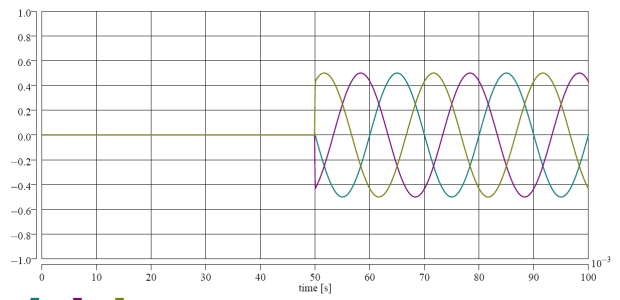
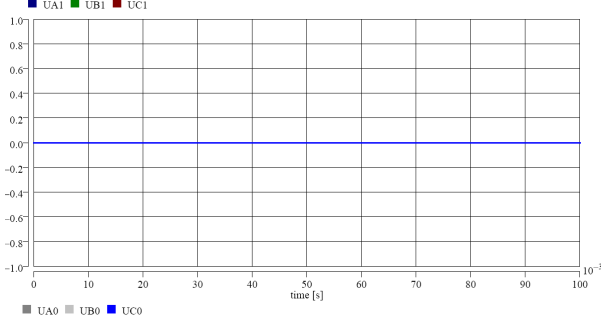
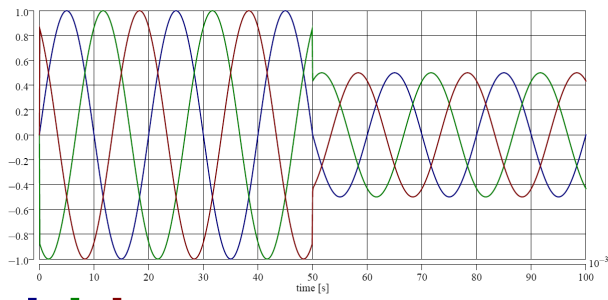

### Dvoufázový zemní zkrat:

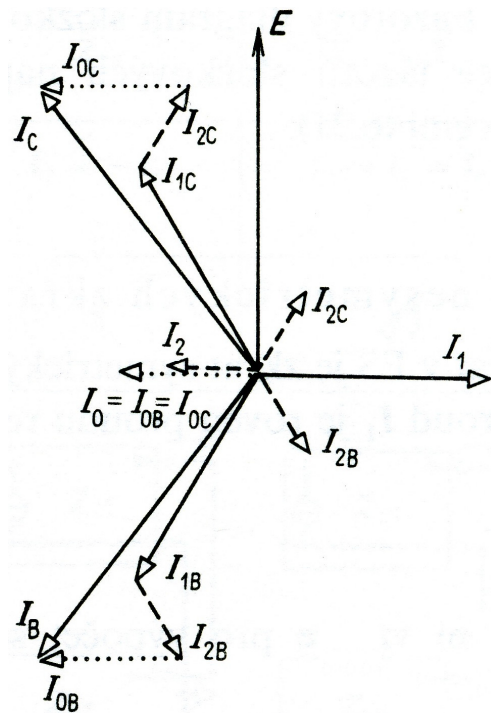
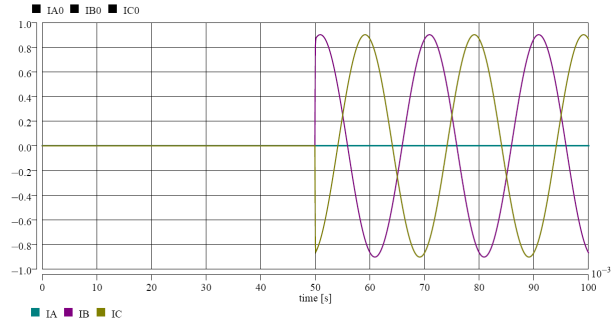
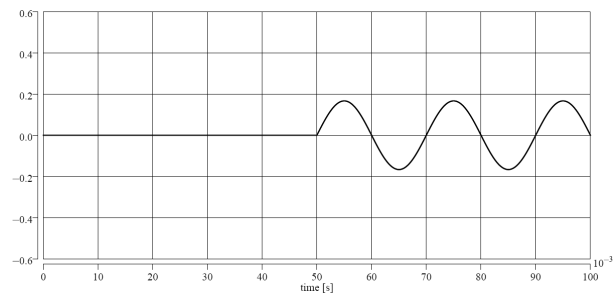
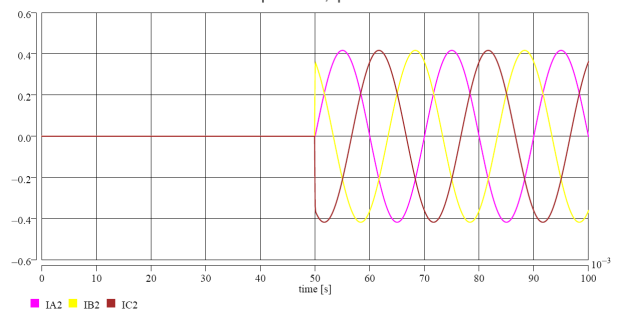
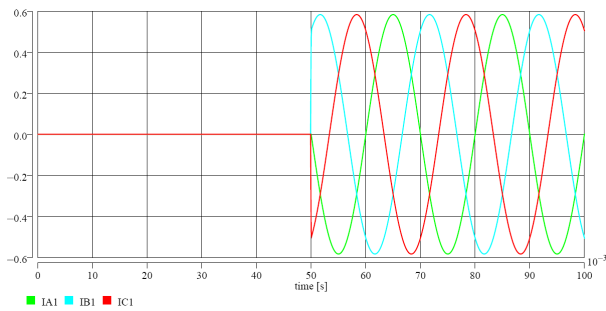
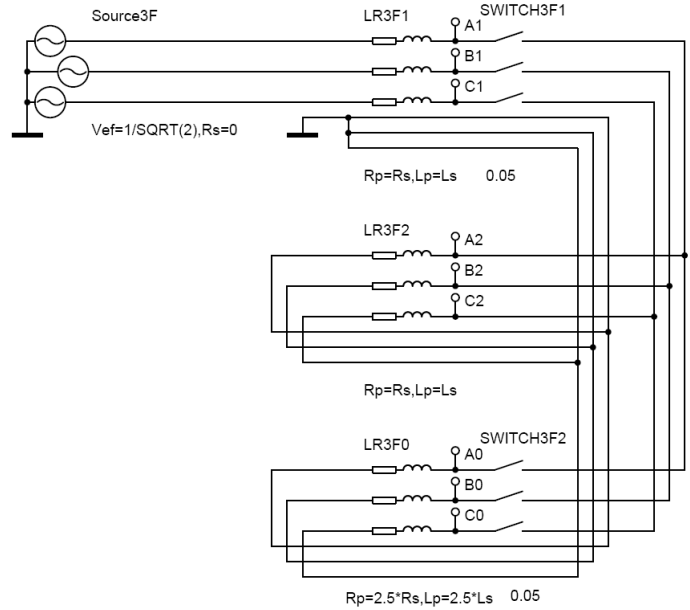
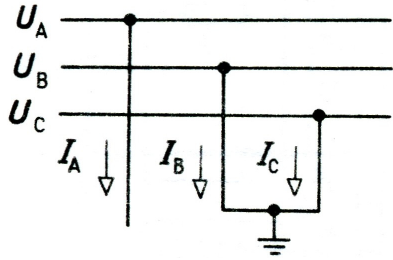

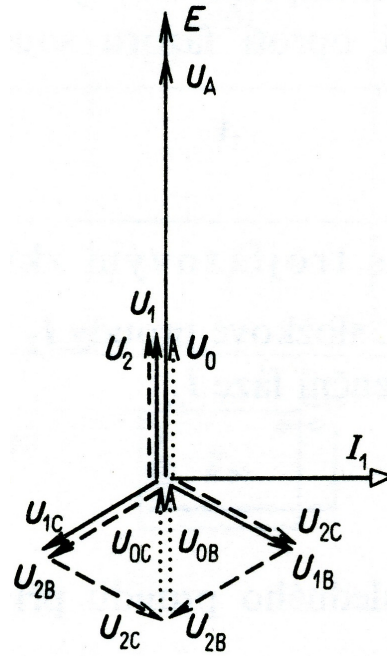
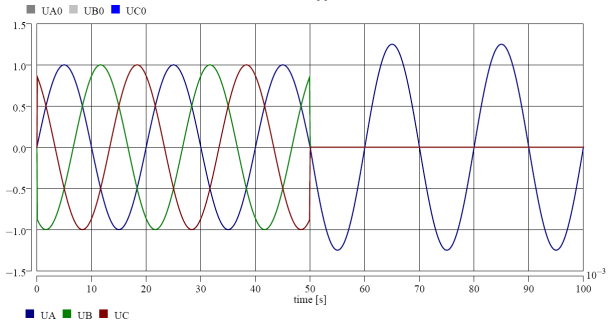
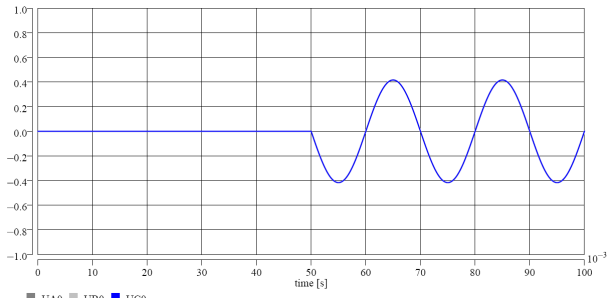
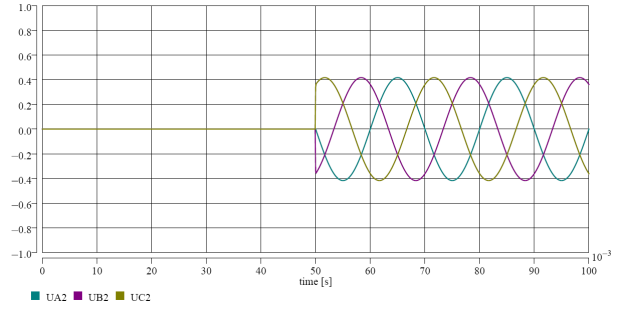
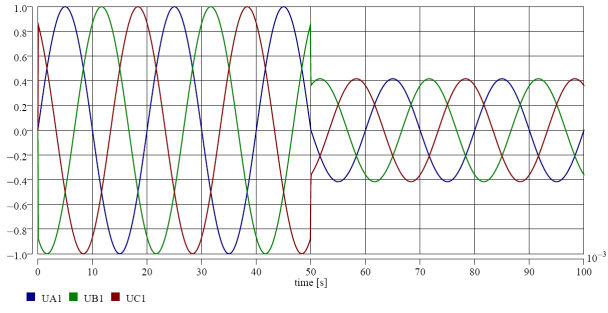

### Třífázový souměrný zkrat:

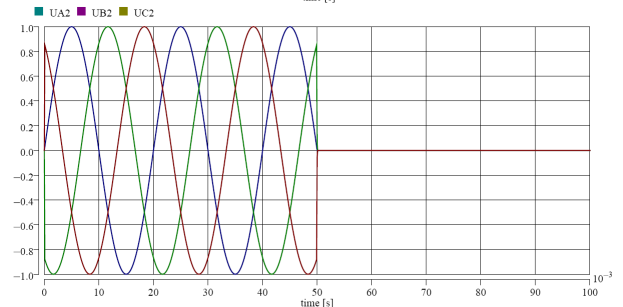
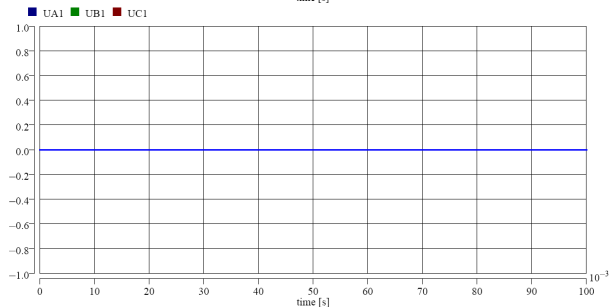
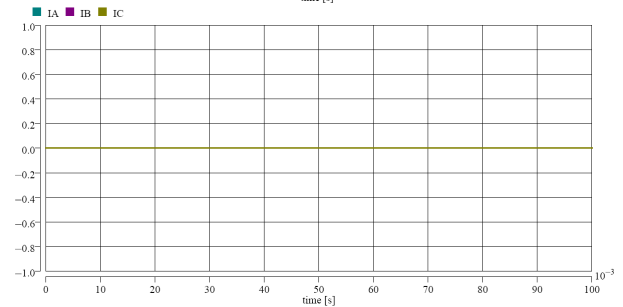
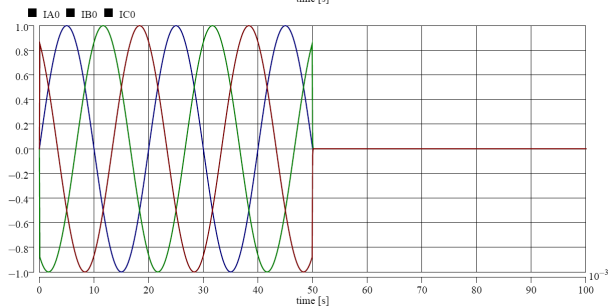
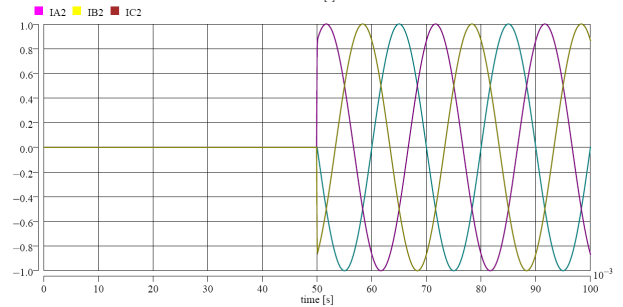
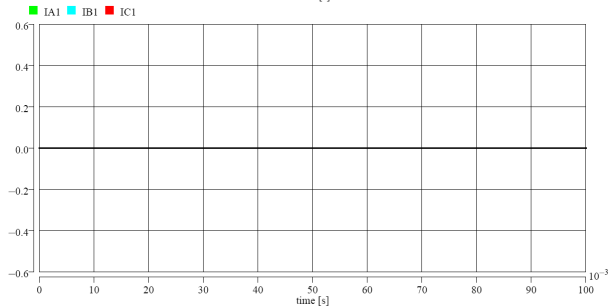
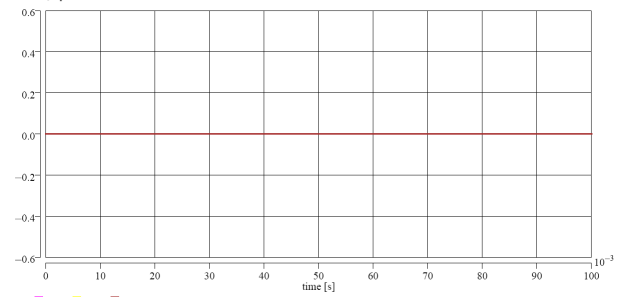
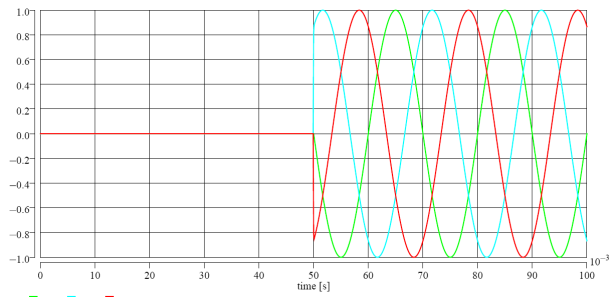
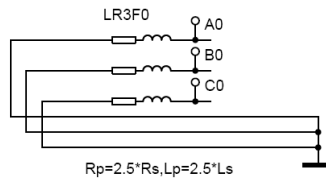
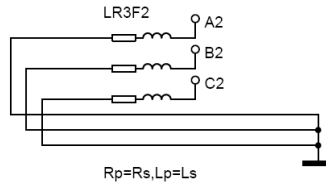
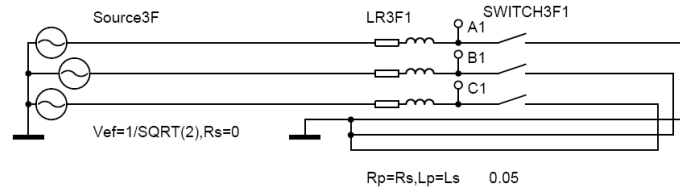

Legend: UA0 (black), UB0 (black), UC0 (black)

Legend: UA (cyan), UB (magenta), UC (yellow)

